

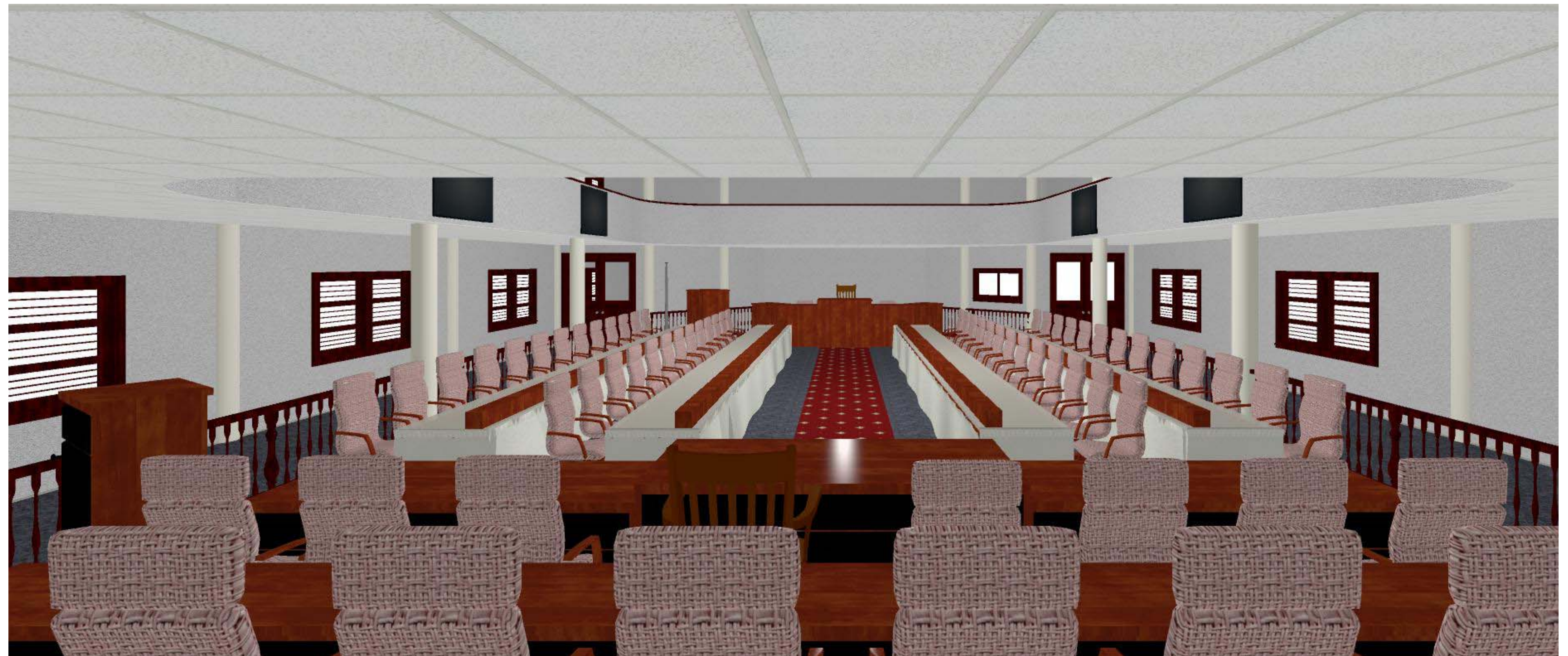

Nieuwe COVID
indeling



Bestaande
situatie

NO.	DESCRIPTION	BY	DATE

SHEET TITLE:
**Herindeling DNA
Vergaderzaal**

PROJECT DESCRIPTION:
**Layout DNA Covid
her-indeling**

DRAWINGS PROVIDED BY:
Ir. ing. D. Mungra
Architect

DATE:
9/12/2020

SCALE:

SHEET:
A-1



Nieuwe COVID indeling

leden platform op hoogten 0-15-30 cm

minimale veranderingen in zaal alleen
balustrade rechterzijde verchoven 25 cm

NO.	DESCRIPTION	BY	DATE

SHEET TITLE:
**Nieuwe COVID
indeling**

PROJECT DESCRIPTION:
**Layout DNA Covid
her-indeling**

DRAWINGS PROVIDED BY:
Ir. ing. D. Mungra
Architect

DATE:
9/12/2020

SCALE:

SHEET:

A-2



**Nieuwe COVID
indeling**

leden regering platform op hoogten 0-20-40 cm

NO.	DESCRIPTION	BY	DATE

SHEET TITLE:
**Nieuwe COVID
indeling**

PROJECT DESCRIPTION:
**Layout DNA Covid
her-indeling**

DRAWINGS PROVIDED BY:
Ir. ing. D. Mungra
Architect

DATE:
9/12/2020

SCALE:

SHEET:
A-3

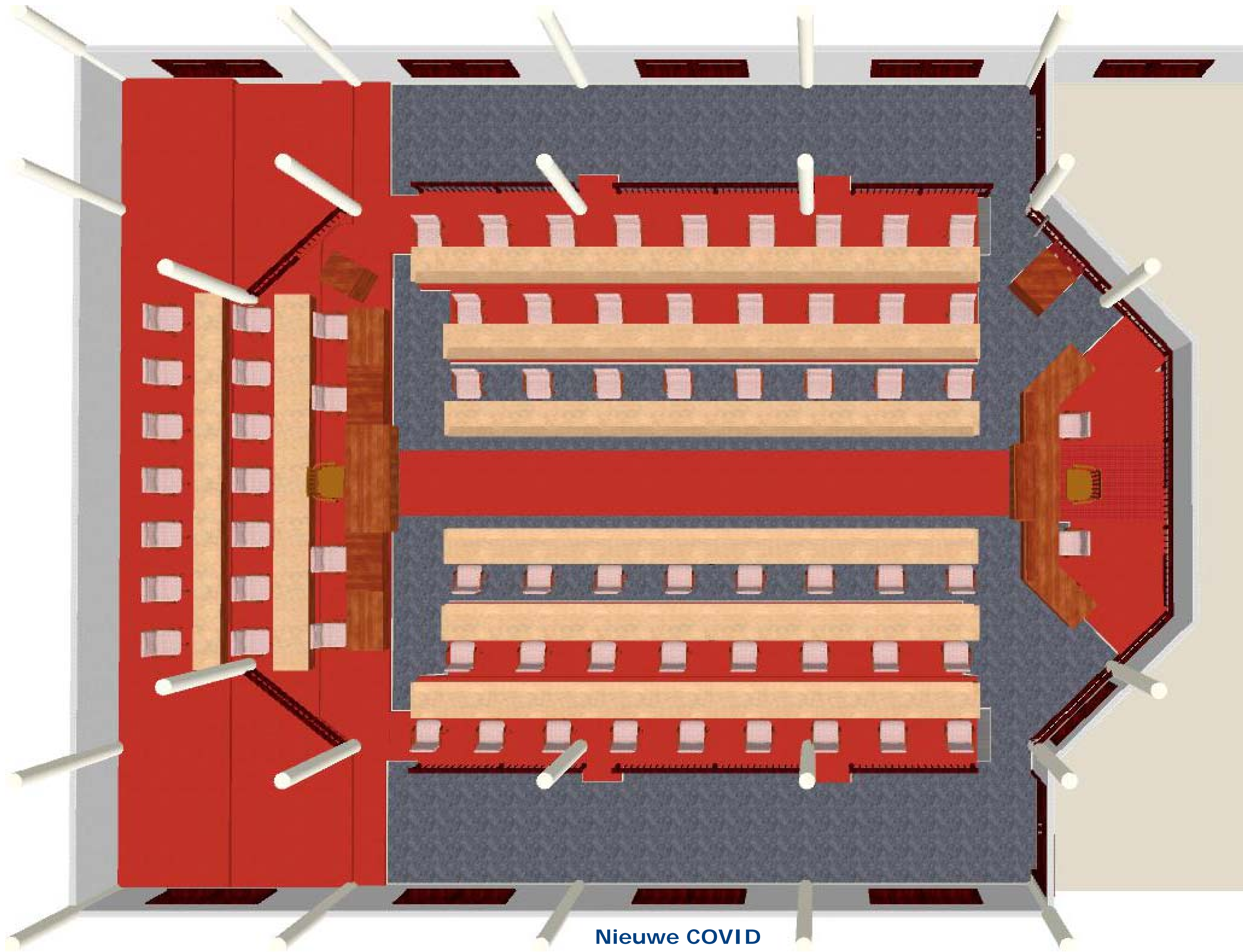

**Nieuwe COVID
indeling**

SHEET:

A-5

SCALE:

9/12/2020

DATE:

DRAWINGS PROVIDED BY:
Ir. ing. D. Mungra
Architect

PROJECT DESCRIPTION:

**Layout DNA Covid
her-indeling**

SHEET TITLE:

**Nieuwe COVID
indeling**

NO. DESCRIPTION

BY

DATE



minimale veranderingen in zaal alleen
 balustrade rechterzijde verchoven 25 cm
 leden platform op hoogten 0-15-30 cm



NO.	DESCRIPTION	BY	DATE

SHEET TITLE:
**Nieuwe COVID
 indeling**

PROJECT DESCRIPTION:
**Layout DNA Covid
 her-indeling**

DRAWINGS PROVIDED BY:
 Ir. ing. D. Mungra
 Architect

DATE:
 9/12/2020

SCALE:

SHEET:

A-6

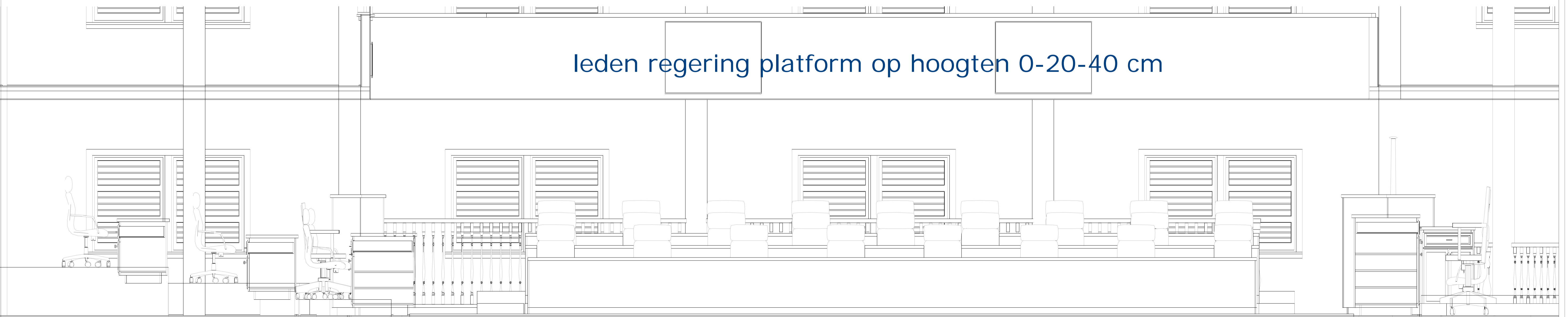

leden regering platform op hoogten 0-20-40 cm

NO.	DESCRIPTION	BY	DATE

SHEET TITLE:
**Nieuwe COVID
 indeling**

PROJECT DESCRIPTION:
**Layout DNA Covid
 her-indeling**

DRAWINGS PROVIDED BY:
 Ir. ing. D. Mungra
 Architect

DATE:
 9/12/2020

SCALE:

SHEET:

A-7

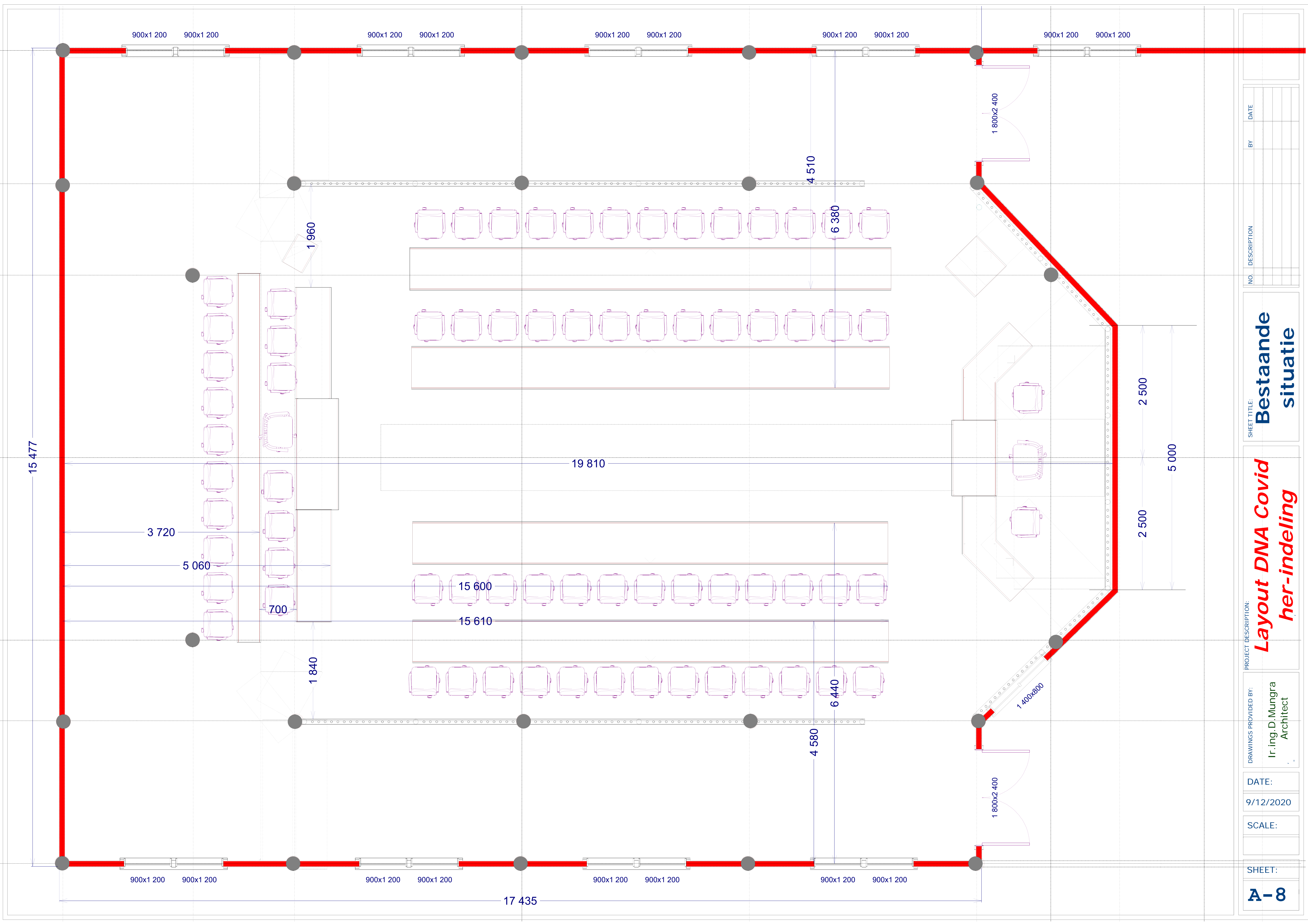

PROJECT DESCRIPTION:		Layout DNA Covid her-indeling	
DRAWINGS PROVIDED BY:		Ir. ing. D. Mungra Architect	
DATE:		9/12/2020	
SCALE:			
SHEET:		A-8	
SHEET TITLE:		Bestaande situatie	
NO.	DESCRIPTION	BY	DATE

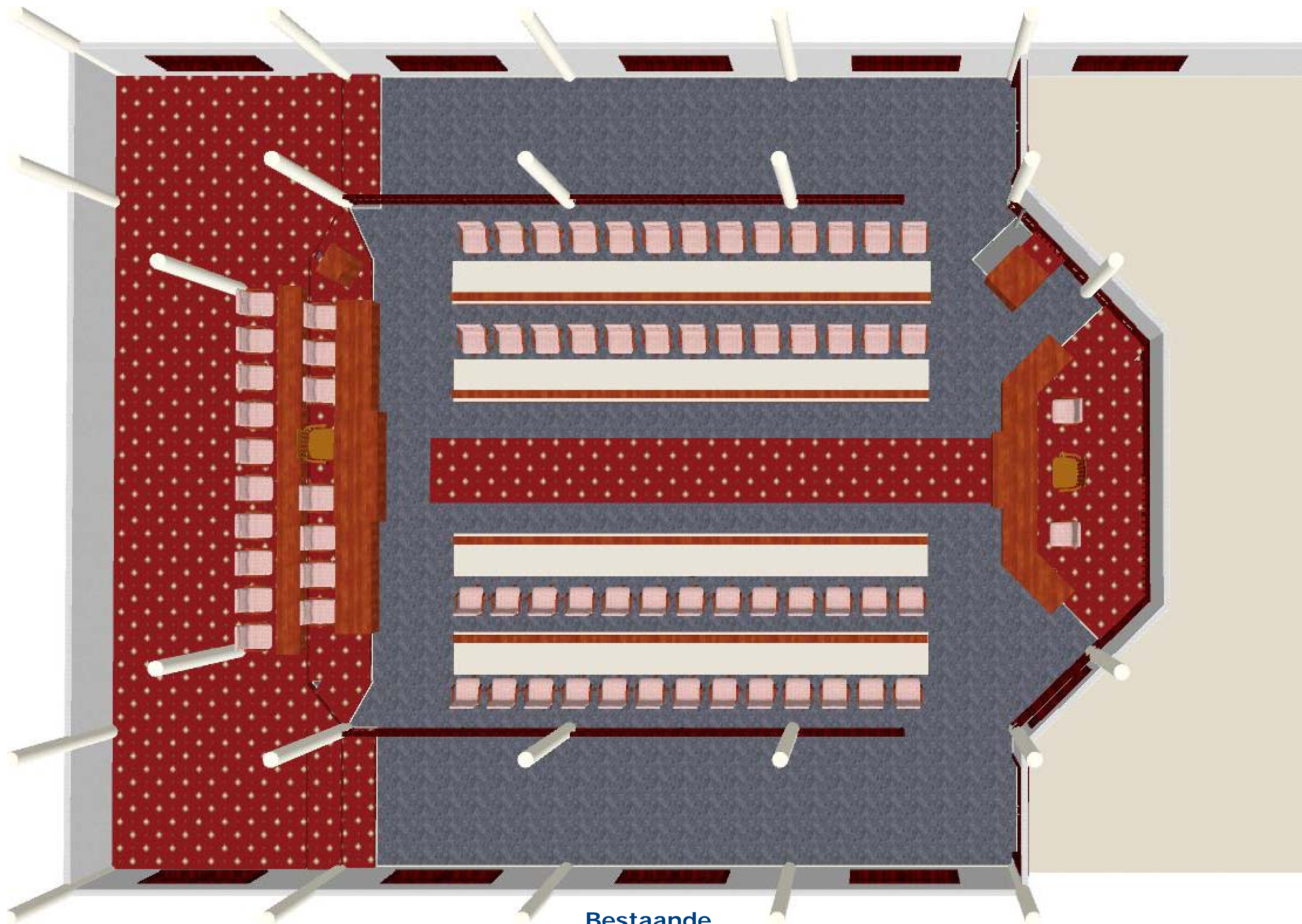

Bestaande
situatie

DRAWINGS PROVIDED BY:
Ir. ing. D. Mungra
Architect

DATE:

9/12/2020

SCALE:

SHEET:

A-9

PROJECT DESCRIPTION:

**Layout DNA Covid
her-indeling**

SHEET TITLE:

**Bestaande
situatie**

NO. DESCRIPTION

BY

DATE

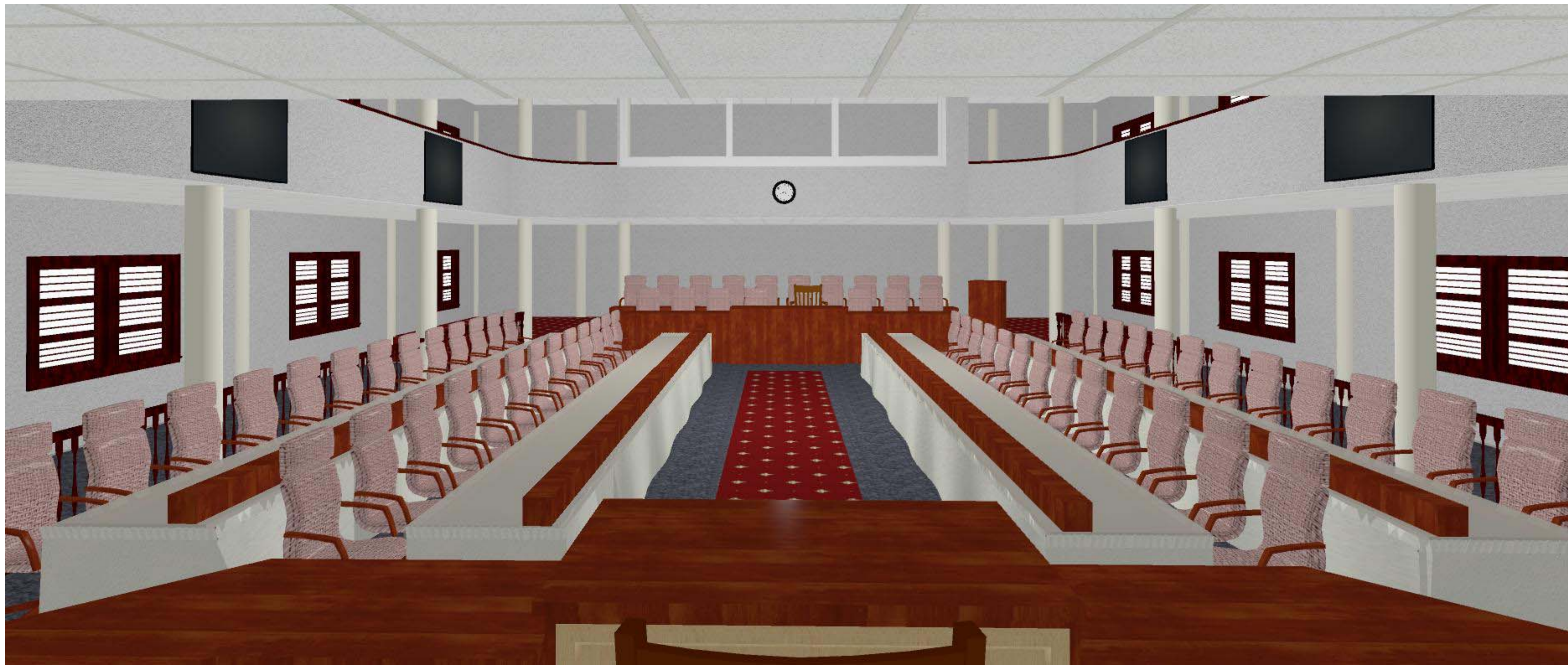

NO.	DESCRIPTION	BY	DATE

SHEET TITLE:
**Bestaande
 situatie**

PROJECT DESCRIPTION:
**Layout DNA Covid
 her-indeling**

DRAWINGS PROVIDED BY:
 Ir. ing. D. Mungra
 Architect

DATE:
 9/12/2020

SCALE:

SHEET:
A-10

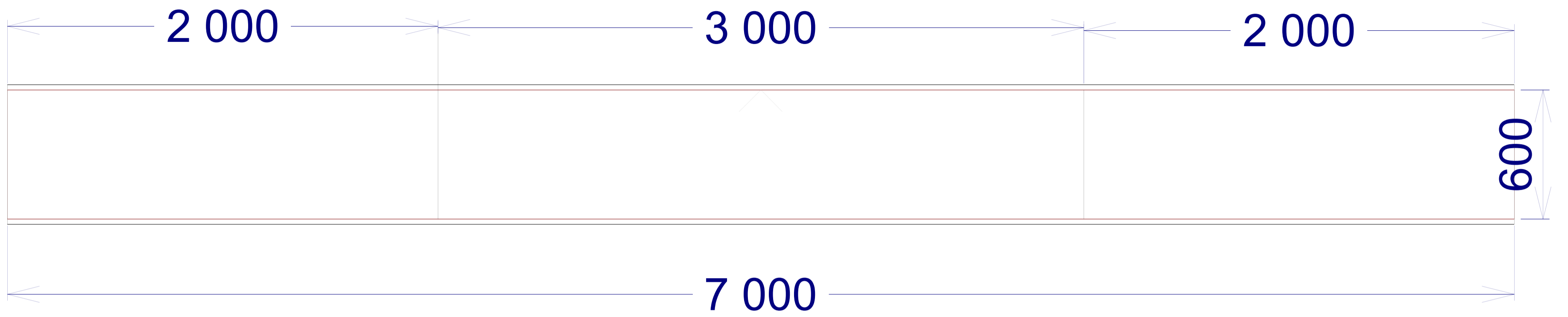
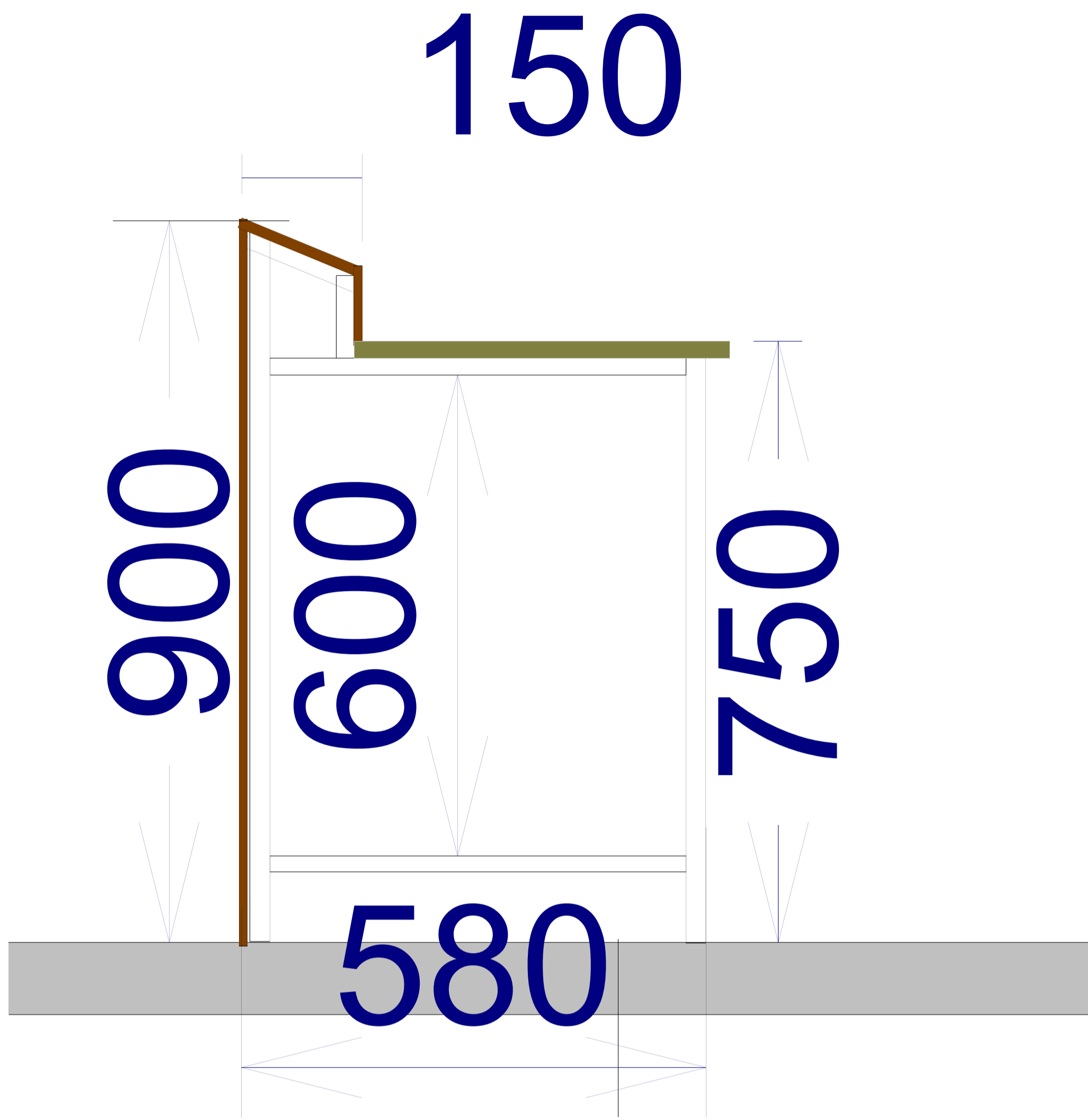

minister tafel
2 X

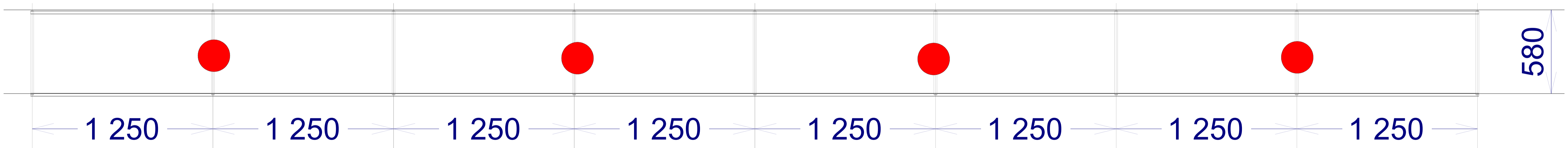

DNA 4 X

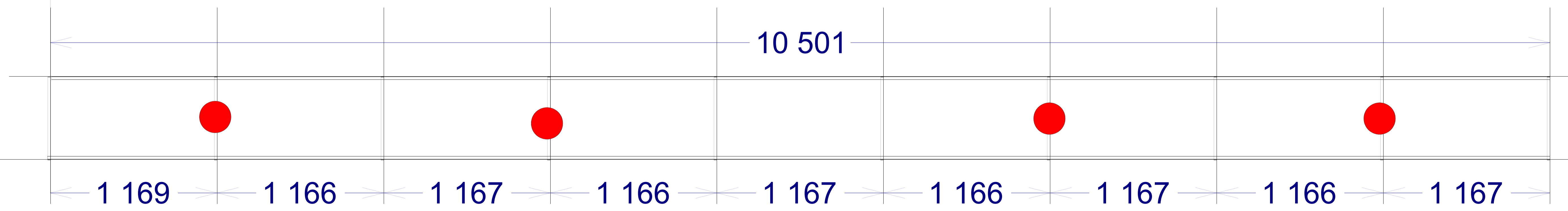

DNA 2 X

NO.	DESCRIPTION	BY	DATE

SHEET TITLE:
**staal
constructie**

PROJECT DESCRIPTION:
**Layout DNA Covid
her-indeling**

DRAWINGS PROVIDED BY:
Ir.ing.D.Mungra
Architect

DATE:
9/12/2020

SCALE:

SHEET:
A-11